

Válvula de assento angular

Angle seat valve

Vanne à siège incliné

Válvula de asiento inclinado



01 83 1077 000

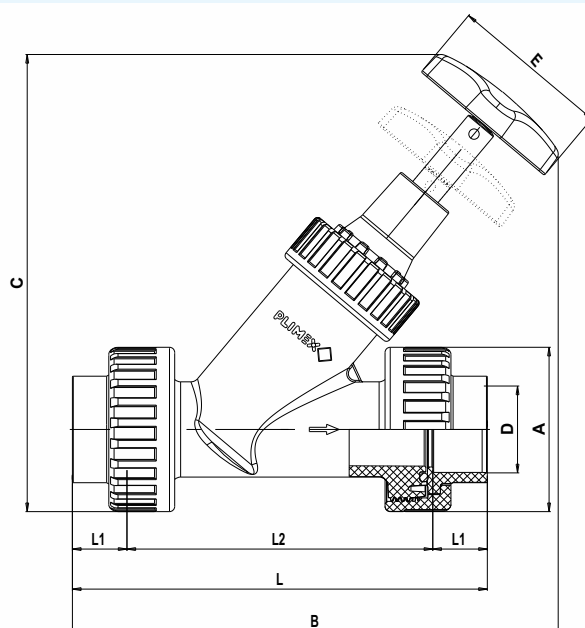

D	DN	PN	A	B	C	E	L	L1	L2	Gr	Quant	Nº Código
25	25	10	68	192	183	59.5	172	19	134	520	F 4	01 83 1077 025
32	25	10	68	199	183	59.5	186	23	140	530	F 4	01 83 1077 032
40	40	10	95	276.5	264	93	231.5	26.5	178.5	1170	F 2	01 83 1077 040
50	40	10	95	280.5	264	93	239.5	31.5	176.5	1180	F 2	01 83 1077 050
63	50	10	115	351	328	117	299.5	38	223.5	2210	F 1	01 83 1077 063
75	50	10	115	354.5	328	117	308	44	220	2165	F 1	01 83 1077 075

Válvula de assento angular transparente

Transparent angle seat valve

Vanne à siège incliné transparent

Válvula asiento inclinado transparente



01 83 1477 000

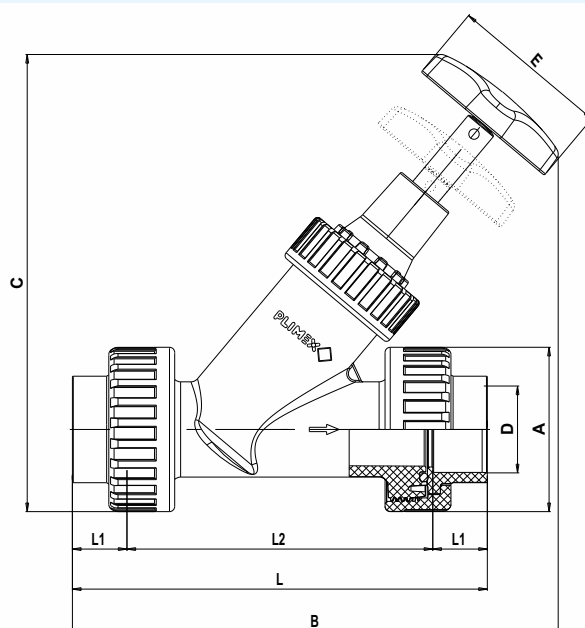

D	DN	PN	A	B	C	E	L	L1	L2	Gr	Quant	Nº Código
25	25	10	68	192	183	59.5	172	19	134	520	F 4	01 83 1477 025
32	25	10	68	199	183	59.5	186	23	140	530	F 4	01 83 1477 032
40	40	10	95	276.5	264	93	231.5	26.5	176.5	1170	F 2	01 83 1477 040
50	40	10	95	280.5	264	93	239.5	31.5	176.5	1180	F 2	01 83 1477 050
63	50	10	115	351	328	117	299.5	38	223.5	2210	F 1	01 83 1477 063
75	50	10	115	354.5	328	117	308	44	220	2165	F 1	01 83 1477 075

Válvula roscada de assento angular

Angle seat tapped valve

Vanne filetée à siège incliné

Válvula roscada asiento inclinado



01 83 1077 000

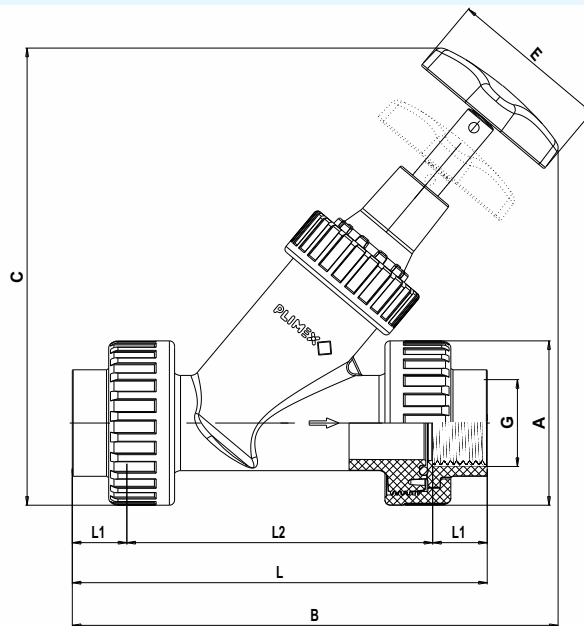

G	DN	PN	A	B	C	E	L	L1	L2	Gr	Quant	Nº Código
"3/4	25	10	68	192	183	59.5	172	16.5	139	520	F 4	01 83 1077 034
1"	25	10	68	199	183	59.5	186	21	144	530	F 4	01 83 1077 100
1"1/4	40	10	95	276.5	264	93	231.5	23	185.5	1170	F 2	01 83 1077 114
1"1/2	40	10	95	280.5	264	93	239.5	23	193.5	1200	F 2	01 83 1077 150
2"	50	10	115	351	328	117	299.5	27	245.5	2265	F 1	01 83 1077 200
2"1/2	50	10	115	354.5	328	117	308	31.5	245	2200	F 1	01 83 1077 250

Válvula roscada de assento angular transparente

Transparent angle seat tapped valve

Vanne filetée à siège incliné transparent

Válvula roscada asiento inclinado transparente



01 83 1477 000

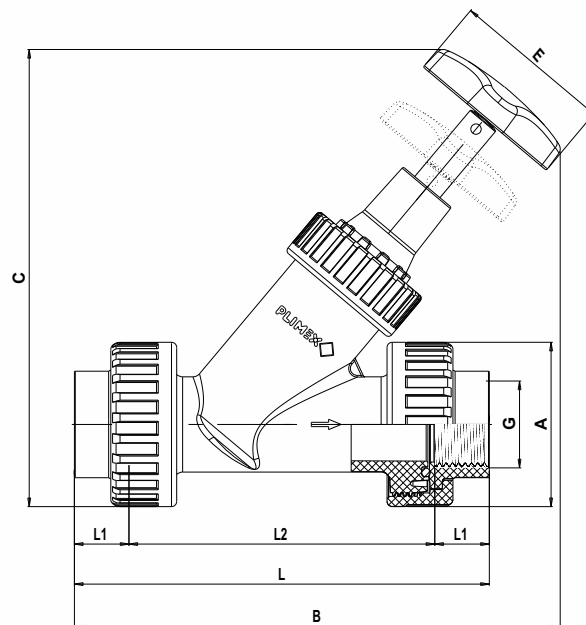

G	DN	PN	A	B	C	E	L	L1	L2	Gr	Quant	Nº Código
"3/4	25	10	68	192	183	59.5	172	16.5	139	520	F 4	01 83 1477 034
1"	25	10	68	199	183	59.5	186	21	144	530	F 4	01 83 1477 100
1"1/4	40	10	95	276.5	264	93	231.5	23	185.5	1170	F 2	01 83 1477 114
1"1/2	40	10	95	280.5	264	93	239.5	23	193.5	1200	F 2	01 83 1477 150
2"	50	10	115	351	328	117	299.5	27	245.5	2265	F 1	01 83 1477 200
2"1/2	50	10	115	355	328	117	307	31	245	2200	F 1	01 83 1477 250